

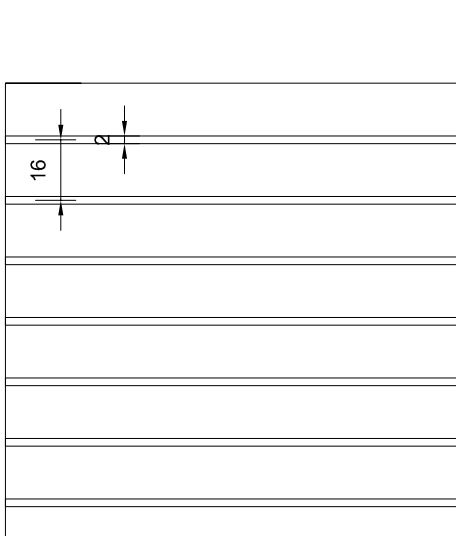

VARION

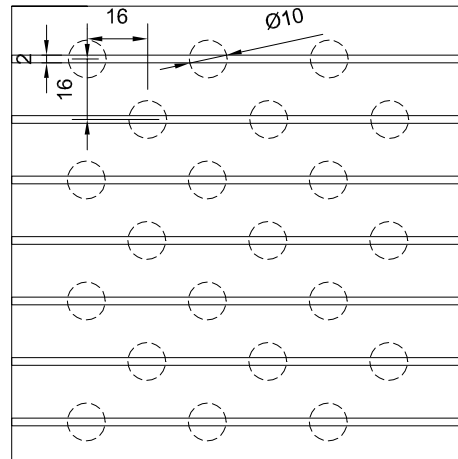

ADVANCE 2/16

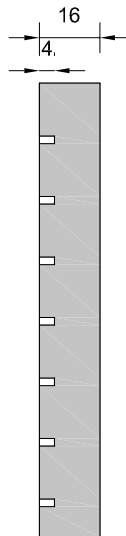

ADVANCE 2/16+10/16x16

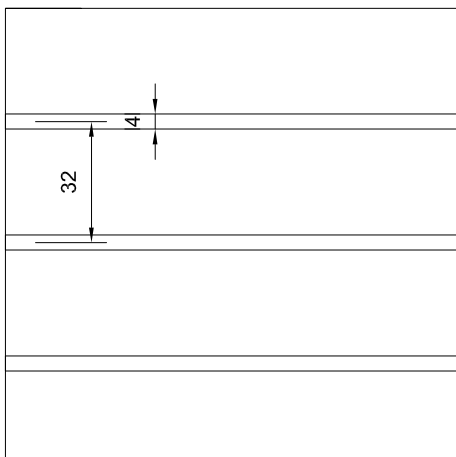
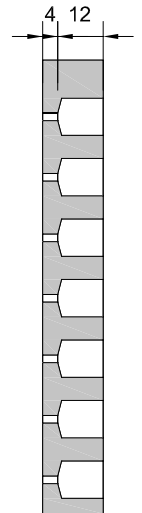

ADVANCE 4/32

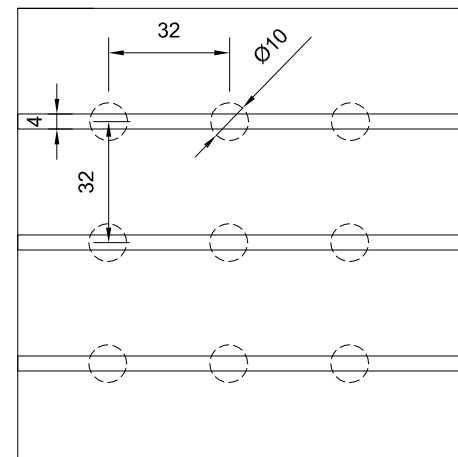
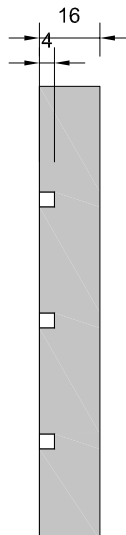

ADVANCE 4/32+10/32x32

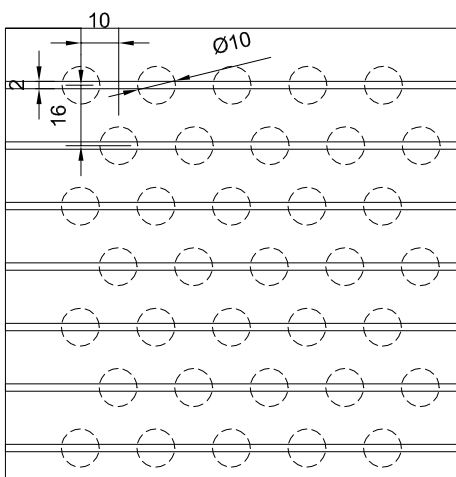
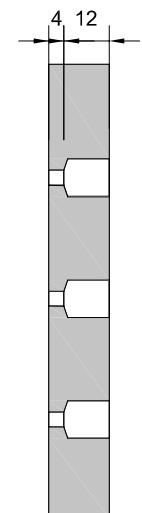

ADVANCE 2/16+10/16x10

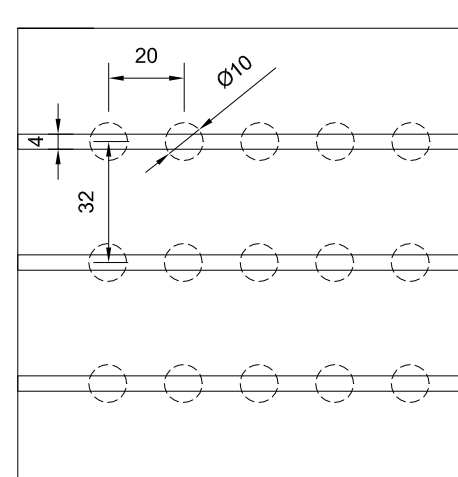
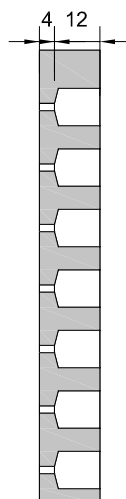

ADVANCE 4/32+10/32x20

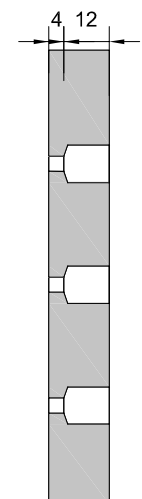



VARION

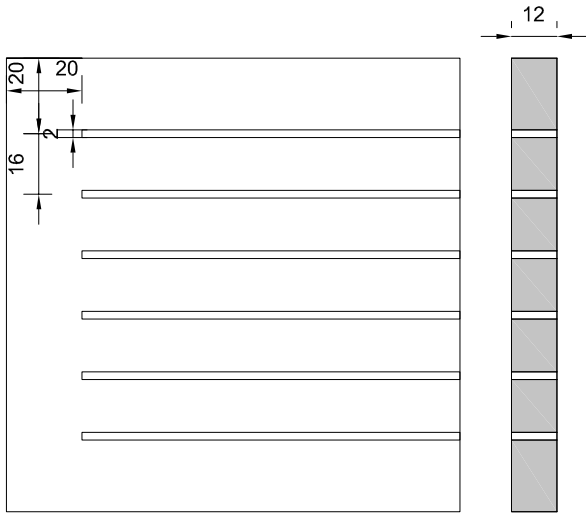

SLOT 16x2P

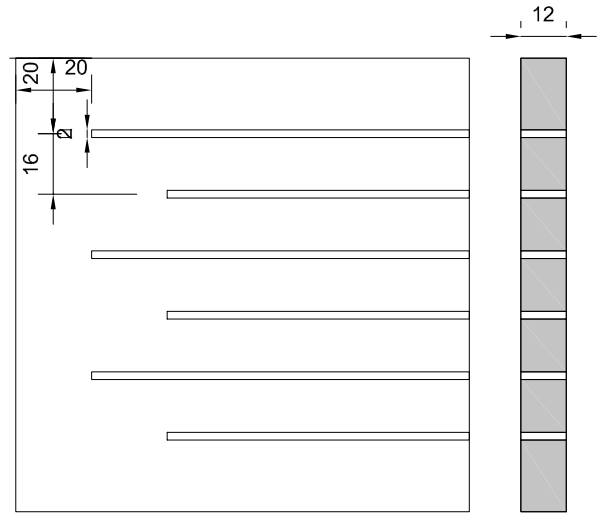

SLOT 16x2D

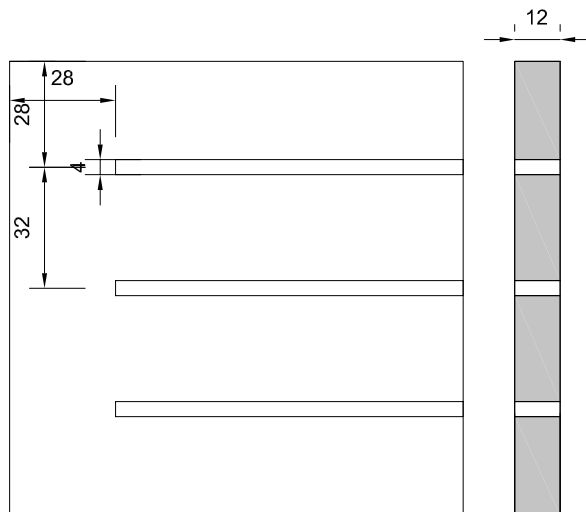

SLOT 32x4P

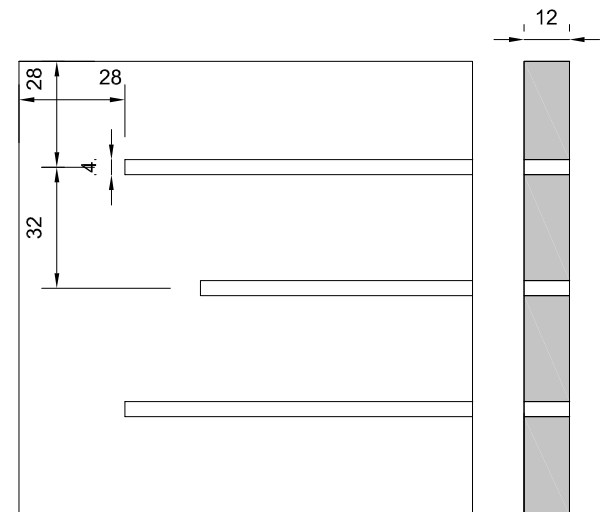

SLOT 32x4D

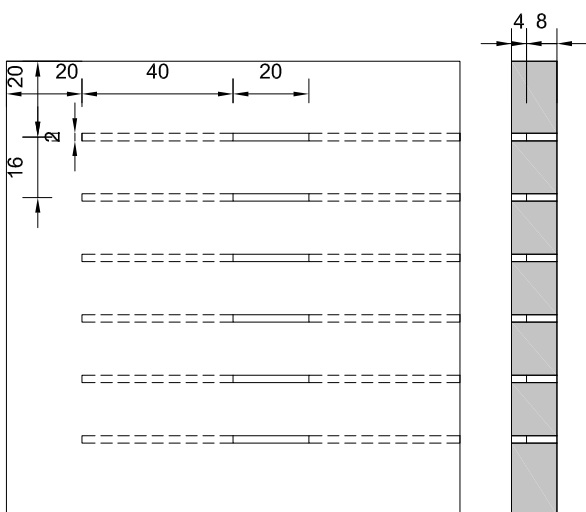

SLOT 16x2P/2x40

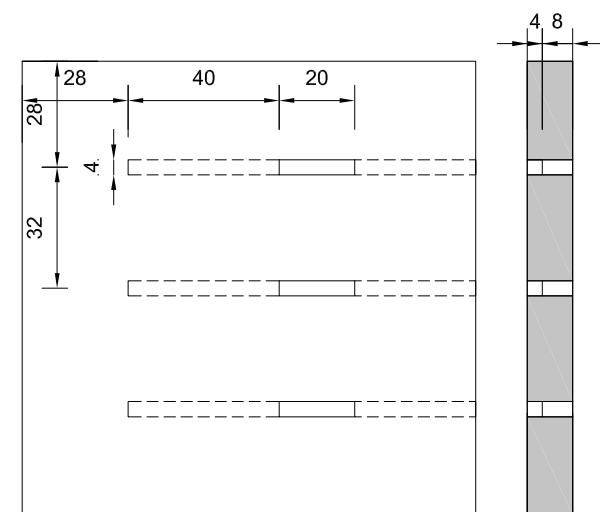

SLOT 32x4P/4x40



VARION

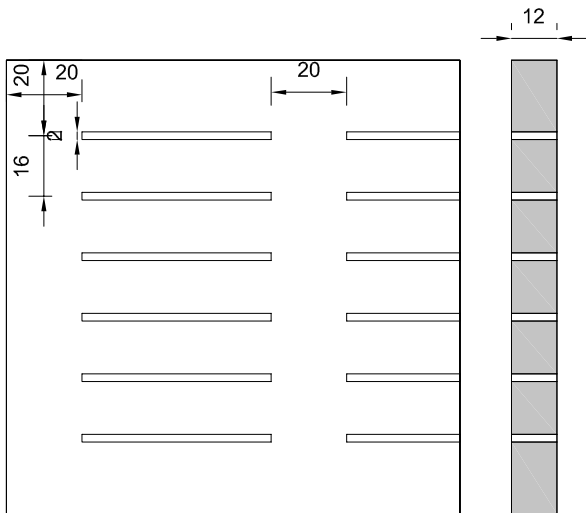

SLOT 16x2P+I00

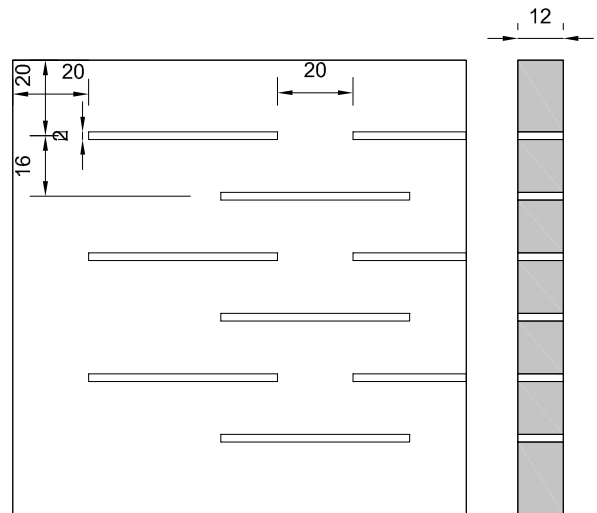

SLOT 16x2D+I00

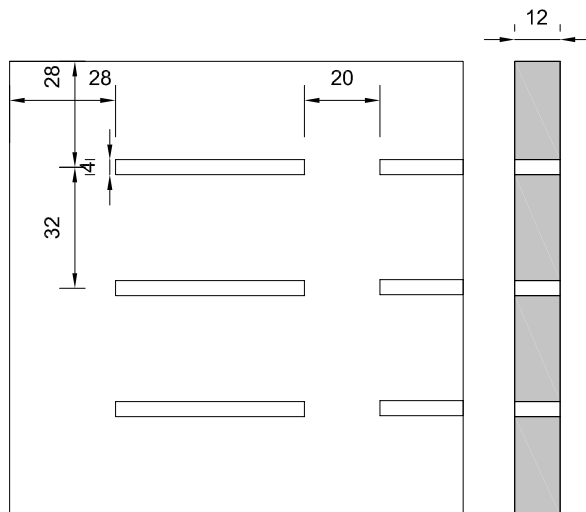

SLOT 32x4P+I00

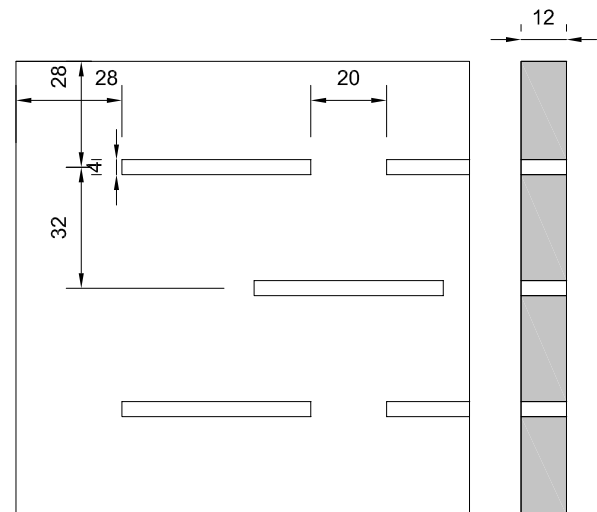

SLOT 32x4P+I00

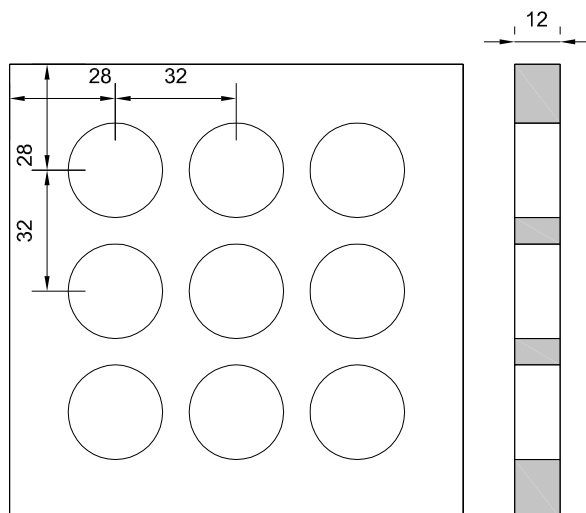

25/32P

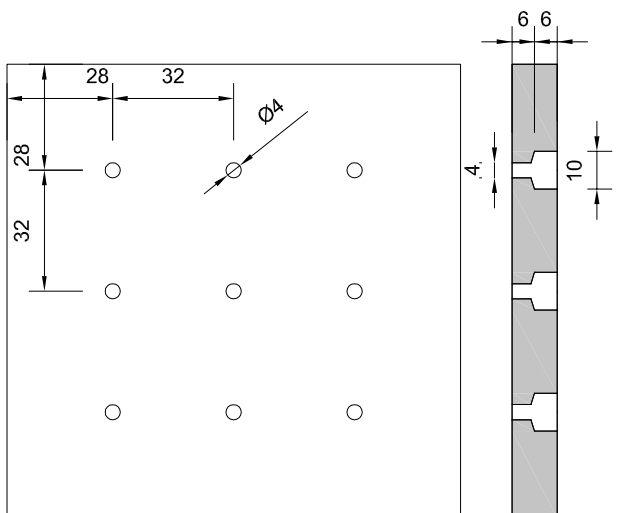

4+10/32P



VARION

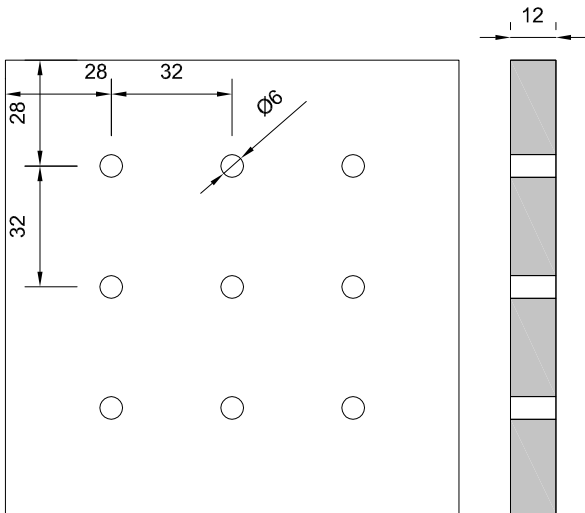

6/32P

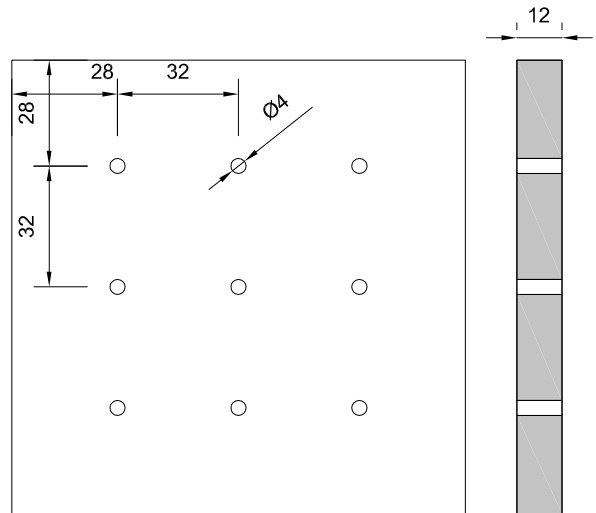

4/32P

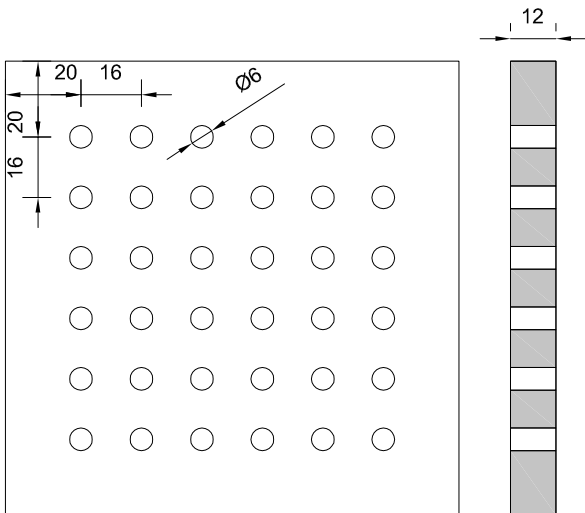

6/16P

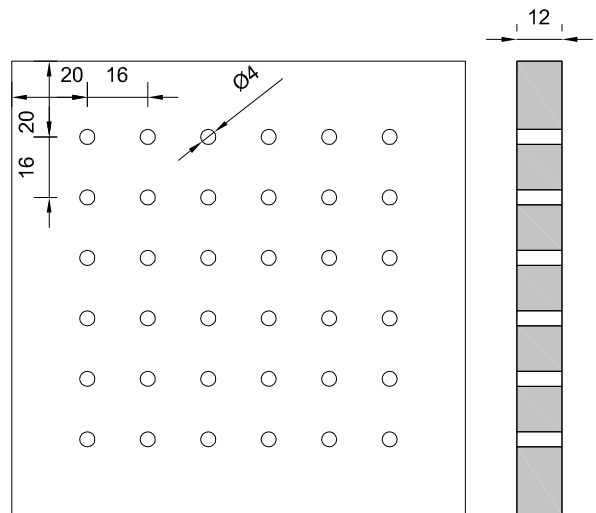

4/16P

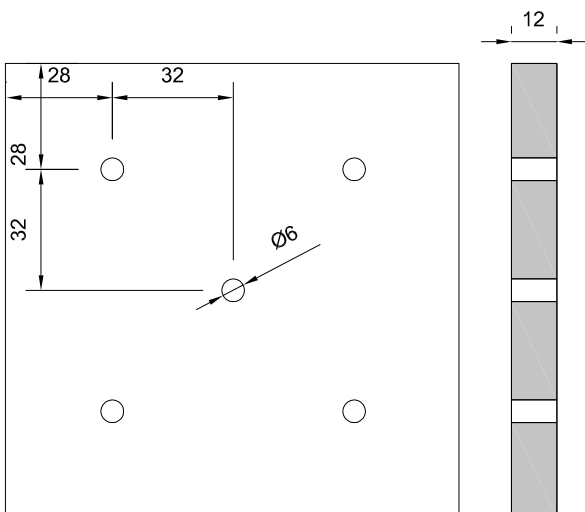

6/32D

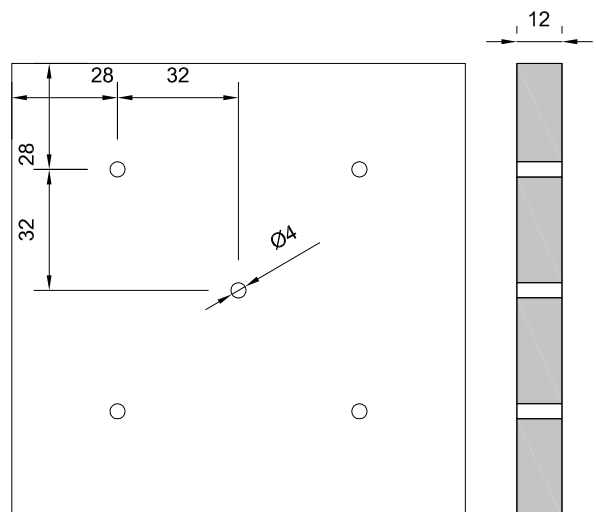

4/32D



VARION

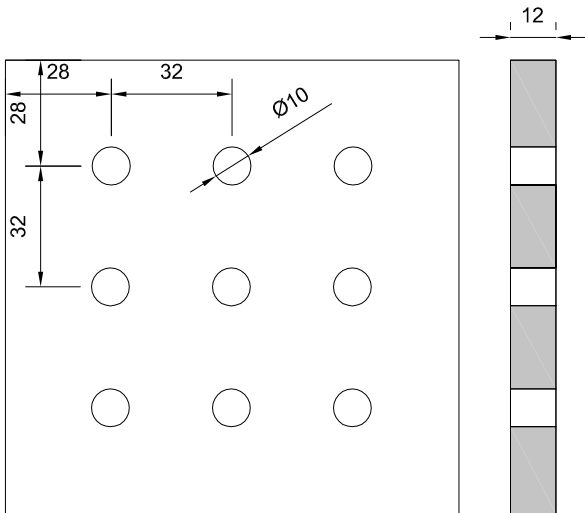

10/32P

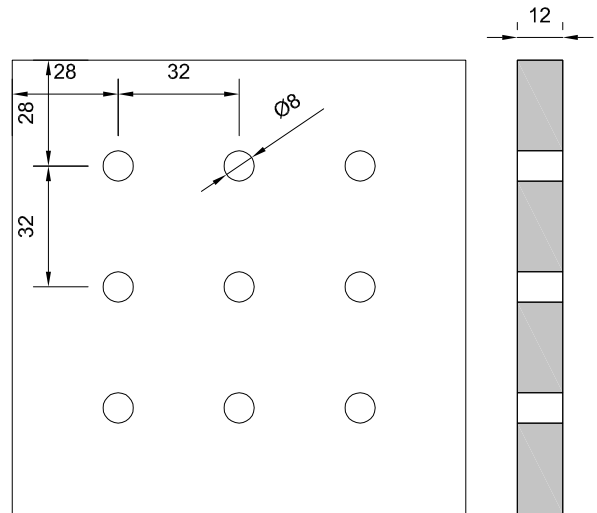

8/32P

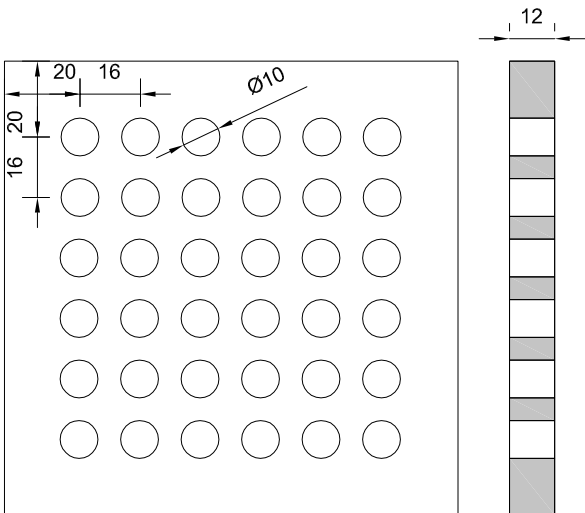

10/16P

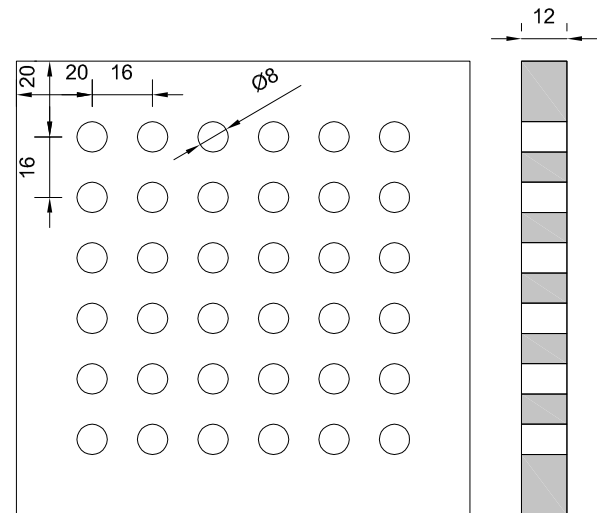

8/16P

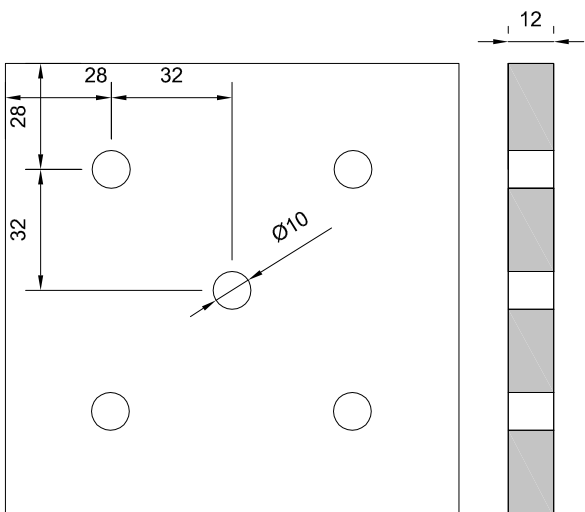

10/32D

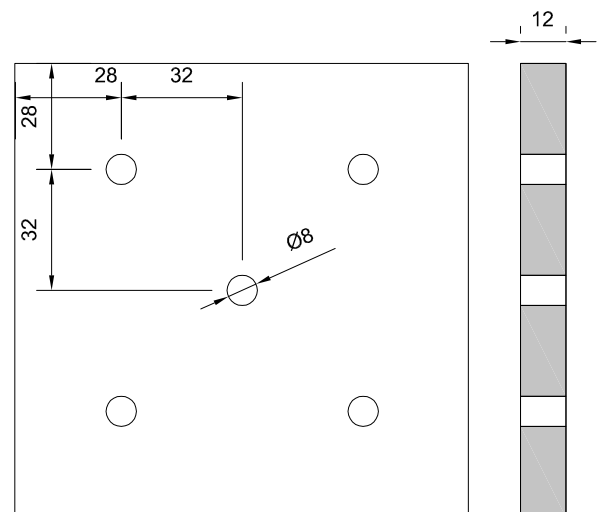

8/32D



VARION

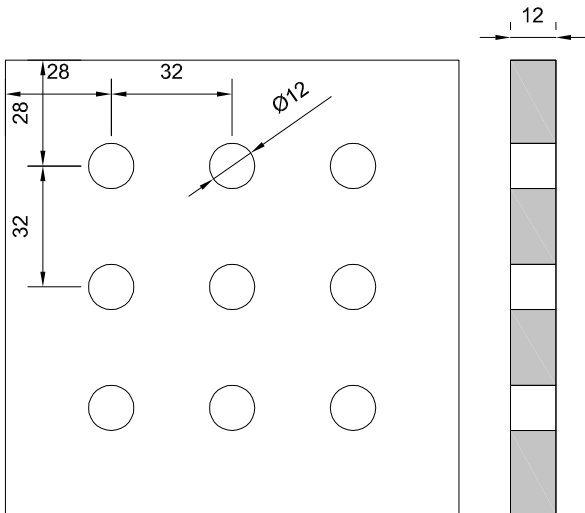

12/32P

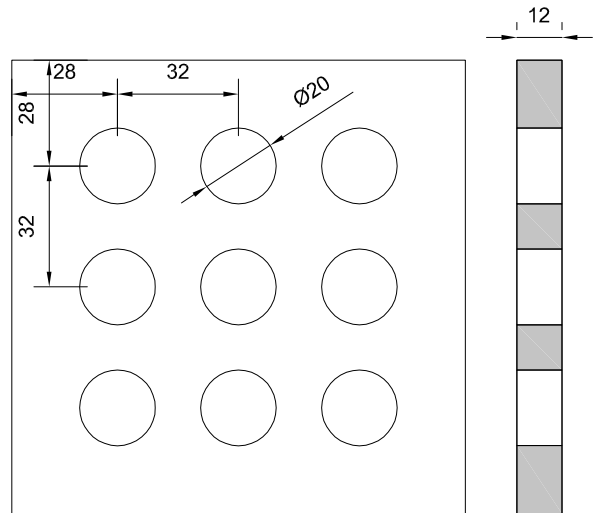

20/32P

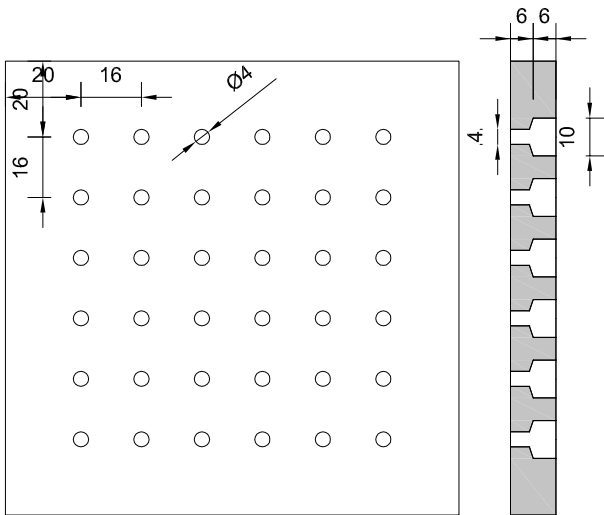

4+10/16P

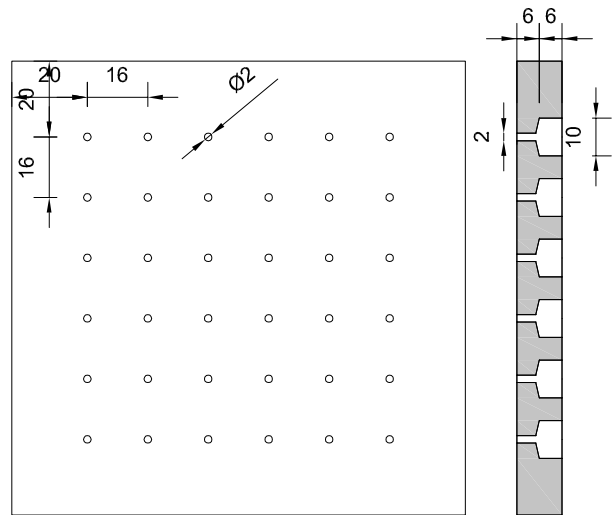

2+10/16P

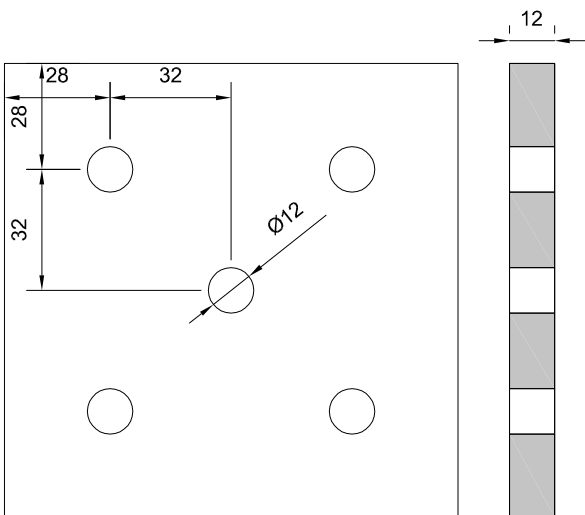

12/32D

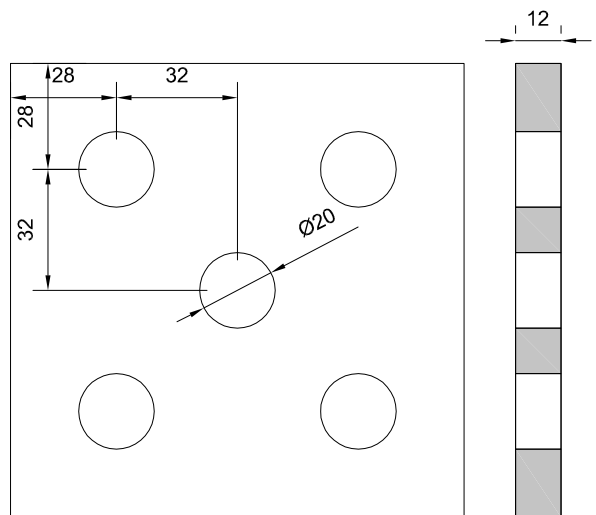

20/32D



VARION

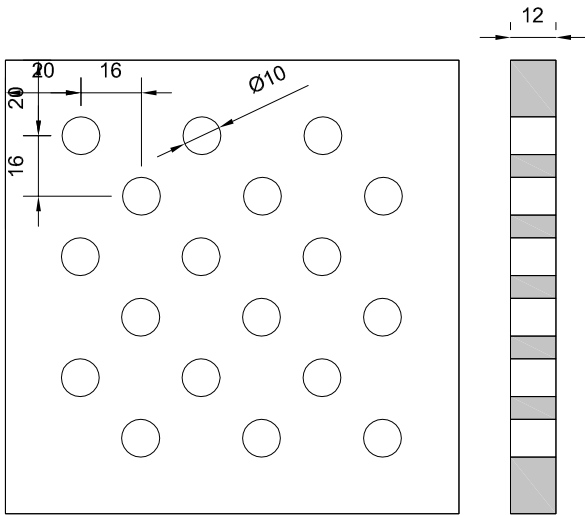

10/16D

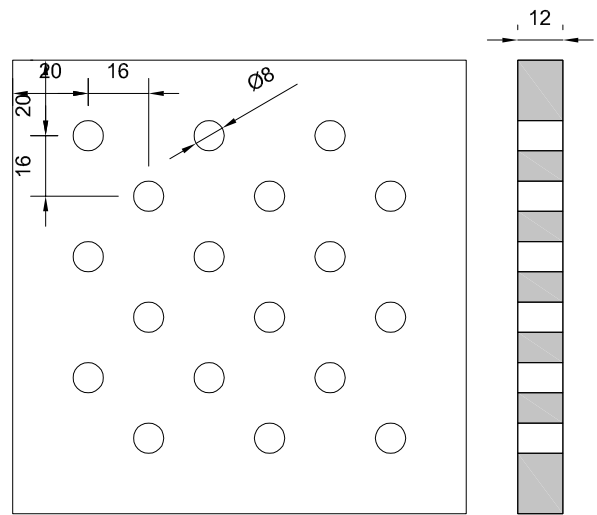

8/16D

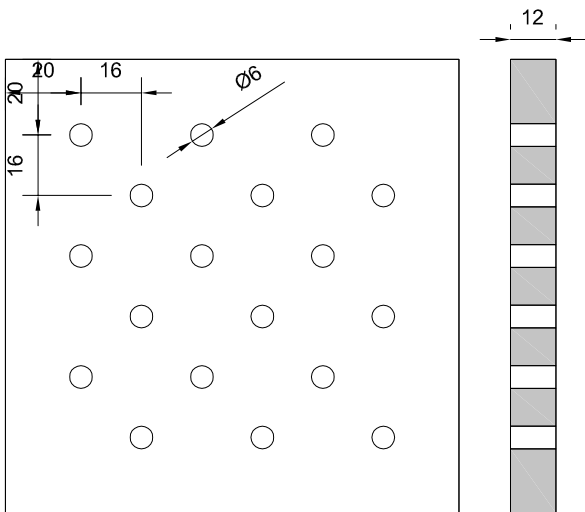

6/16D

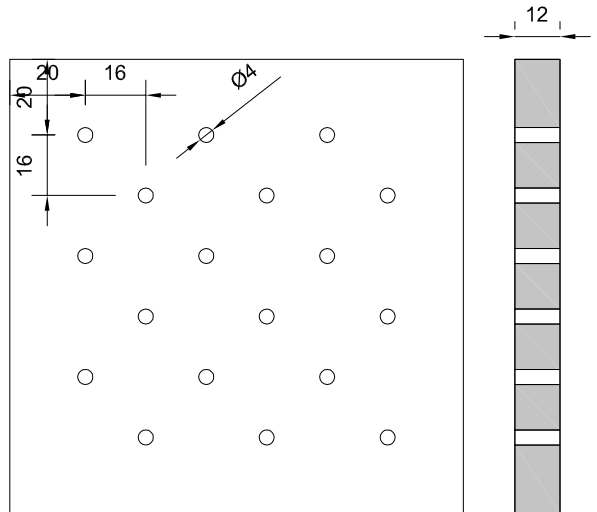

4/16D

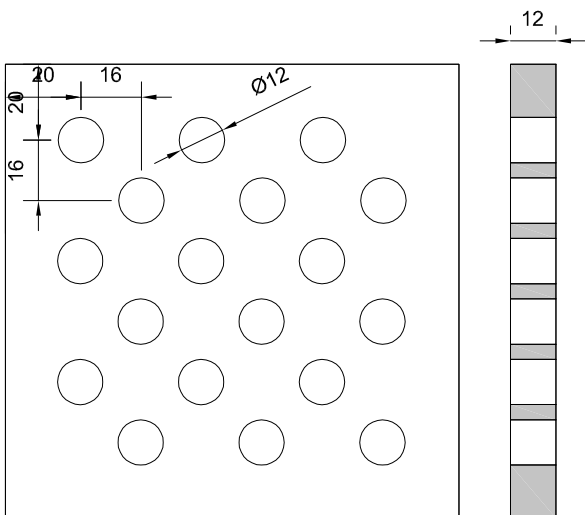

12/16D

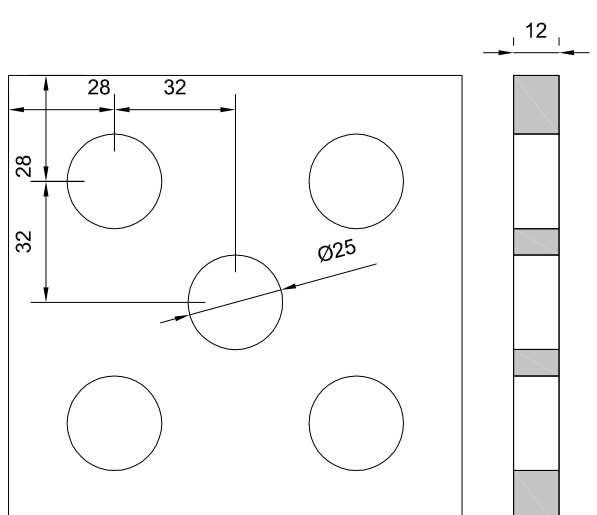

25/32D